

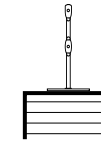

Nixalite® FliteLine Post Row Spacing Double Exposed Installation Surfaces



Double Exposed
Any surface without any bordering walls or blocking objects (except for diameters - pipes, cables, etc.)

Scale: 1/2" = 1"

Metric equivalents in centimeters (cm)

6-1/2" (16.51cm) Surface Depth

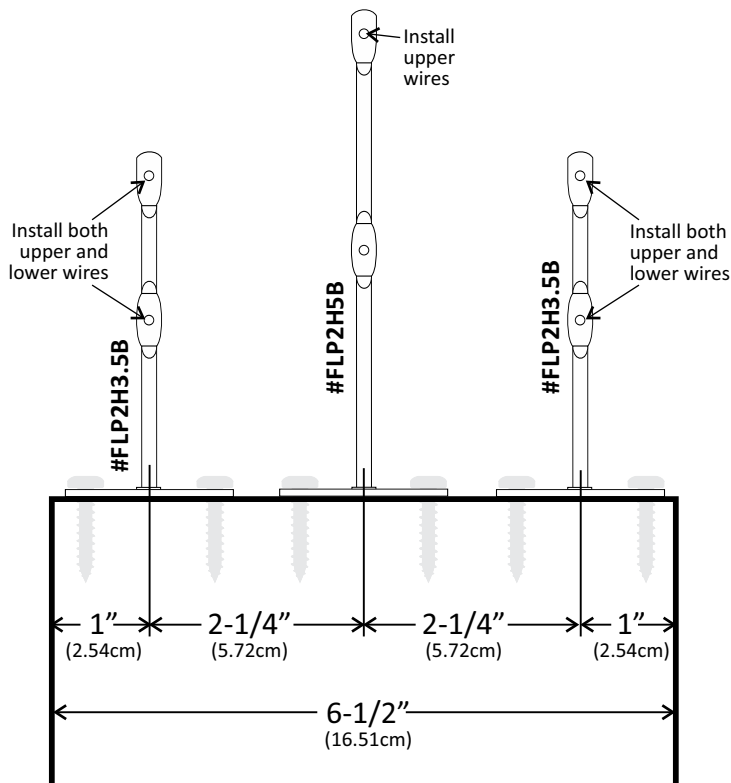

7" (17.78cm) Surface Depth

